



XTR2N0500

High Temperature 35V P-Channel Power MOSFET

Rev 5 – November 2023 (DS-00150-12)

Data Sheet



PRODUCTION



CDIP8
XTR2N0525



CDFP8
XTR2N0525



FEATURES

- Minimum $BV_{DSS} = -40V$.
- Allowed V_{GS} range $-5.5V$ to $+5.5V$.
- Operational beyond the $-60^{\circ}C$ to $+230^{\circ}C$ temperature range.
- Low $R_{DS(on)}$
 - XTR2N0525: 2.3Ω @ $230^{\circ}C$
 - XTR2N0550: 1.1Ω @ $230^{\circ}C$
- Maximum Peak I_D :
 - XTR2N0525: $5.3 A$ @ $230^{\circ}C$
 - XTR2N0550: $11.7 A$ @ $230^{\circ}C$
- On-time ($t_{d(on)} + t_r$):
 - XTR2N0525: $26 nsec$ @ $230^{\circ}C$
 - XTR2N0550: $31 nsec$ @ $230^{\circ}C$
- Off-time ($t_{d(off)} + t_f$):
 - XTR2N0525: $76 nsec$ @ $230^{\circ}C$
 - XTR2N0550: $91 nsec$ @ $230^{\circ}C$
- Ruggedized 3-lead TO257, 8-lead side brazed DIP and 8-lead gull-wing flat pack with ePAD.
- Also available as tested bare die.

APPLICATIONS

- Reliability-critical, Automotive, Aeronautics & Aerospace, Down-hole.
- DC/DC converters, power switching, motor control, power inverters, power linear regulators, power supply.

DESCRIPTION

XTR2N0500 is a family of 35V P-channel power MOSFETs designed to reliably operate over a wide range of temperatures. Full functionality is guaranteed from $-60^{\circ}C$ to $+230^{\circ}C$, though operation well below and above this temperature range is achieved. Fabricated in a Silicon-on-Insulator (SOI) process, XTR2N0500 family parts offer reduced leakage currents while providing high drain currents and low $R_{DS(on)}$. These features allow XTR2N0500 parts to be ideally suited for switching and linear applications. XTR2N0500 family parts have been designed to reduce system cost and ease adoption by reducing the learning curve and providing smart and easy to use features. Parts from the XTR2N0500 family are available in ruggedized 8-lead side brazed DIP and 8-lead gull-wing flat pack with ePAD. Parts are also available as tested bare die.

PRODUCT HIGHLIGHT

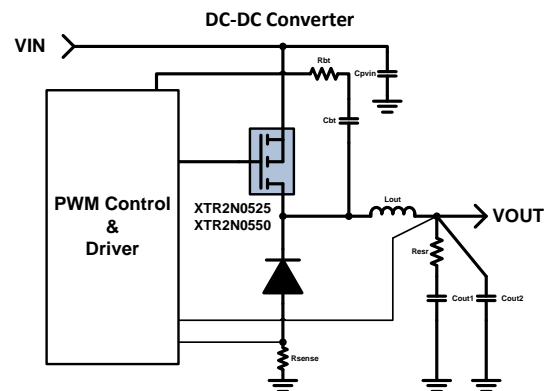
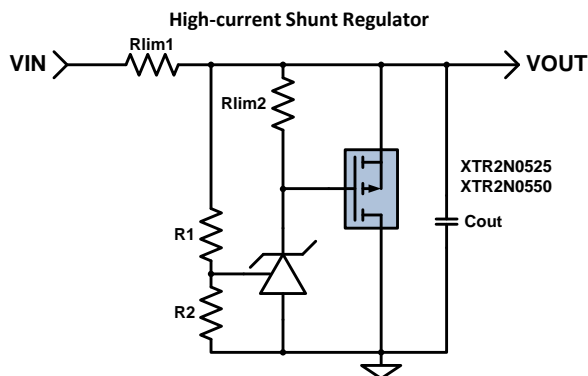

ORDERING INFORMATION

X
↓
Source :
X = X-REL Semi

TR
↓
Process:
TR = HiTemp, HiRel

2N
↓
Part family

05xx
↓
Part number

Product Reference	Temperature Range	Package	Pin Count	Marking
XTR2N0525-TD	-60°C to +230°C	Tested bare die		
XTR2N0525-D	-60°C to +230°C	Ceramic side brazed DIP	8	XTR2N0525
XTR2N0525-FE	-60°C to +230°C	Gull-wing flat pack with ePad	8	XTR2N0525
XTR2N0550-TD	-60°C to +230°C	Tested bare die		

Other packages and packaging configurations possible upon request. For some packages or packaging configurations, MOQ may apply.

ABSOLUTE MAXIMUM RATINGS

Drain-source voltage	-40V to +2V
Gate-source voltage	±6.0V
Storage temperature range	-70°C to +230°C
Operating junction temperature range	-70°C to +300°C
ESD classification	2kV HBM MIL-STD-750

Caution: Stresses beyond those listed in "ABSOLUTE MAXIMUM RATINGS" may cause permanent damage to the device. These are stress ratings only and functionality of the device at these or any other condition beyond those indicated in the operational sections of the specifications is not implied. Exposure to "ABSOLUTE MAXIMUM RATINGS" conditions for extended periods may permanently affect device reliability.

PRODUCT VARIANTS

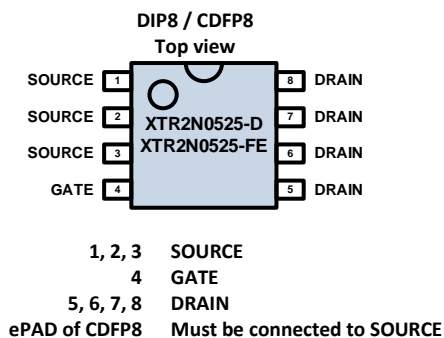

THERMAL CHARACTERISTICS

Parameter	Condition	Min	Typ	Max	Units
XTR2N0525-D (DIP8)					
Thermal Resistance: J-C R_{Th_J-C}			20		°C/W
Thermal Resistance: J-A R_{Th_J-A}	Still air.		100		°C/W
XTR2N0525-FE (DFP8 with exposed pad)					
Thermal Resistance: J-C R_{Th_J-C}	Measured on ePAD.		7		°C/W
Thermal Resistance: J-A R_{Th_J-A}	ePAD thermally connected to 3cm ² PCB copper		70		°C/W

RECOMMENDED OPERATING CONDITIONS

Parameter	Min	Typ	Max	Units
Drain-source voltage V_{DS}	-35		1.5	V
Gate-source voltage V_{GS}	-5.5		+5.5	V
Junction Temperature ¹ T_j	-60		230	°C

¹ Operation beyond the specified temperature range is achieved. The -60°C to +230°C range for the case temperature is considered for the case where $I_D \leq I_{D(DC)}$ for a given case temperature.

XTR2N0525 SPECIFICATIONS

Unless otherwise stated, specification applies for $-60^{\circ}\text{C} < T_J < 230^{\circ}\text{C}$.

Parameter	Condition	Min	Typ	Max	Units
DC Characteristics					
Drain-source breakdown voltage V_{DSS}	$V_{GS}=0\text{V}$, $I_{DS}=-100\mu\text{A}$	-40			V
Static drain-source on-state resistance $R_{DS(on)}$	$V_{GS}=-5\text{V}$, $I_{DS}=-100\text{mA}$ $T_C=-60^{\circ}\text{C}$ $T_C=85^{\circ}\text{C}$ $T_C=230^{\circ}\text{C}$		1.1 1.6 2.3	1.5 2.1 3.0	Ω
Continuous drain current $I_{D(C)}$	$V_{GS}=-5\text{V}$ $T_J=-60^{\circ}\text{C}$ $T_J=85^{\circ}\text{C}$ $T_J=230^{\circ}\text{C}$	-1.5 -1.1 -0.9	-2.2 -1.6 -1.3		A
Gate threshold voltage $V_{GS(th)}$	$V_{DS}=V_{GS}$, $I_{DS}=-1\text{mA}$ $T_C=-60^{\circ}\text{C}$ $T_C=85^{\circ}\text{C}$ $T_C=230^{\circ}$		-1.27 -0.98 -0.60		V
Temperature drift of gate threshold voltage $\Delta V_{GS(th)}/\Delta T_J$	$V_{DS}=V_{GS}$, $I_{DS}=-1\text{mA}$		2.31		mV/ $^{\circ}\text{C}$
Off-state drain current I_{DSS}	$V_{DS}=-35\text{V}$, $V_{GS}=0\text{V}$ $T_C=85^{\circ}\text{C}$ $T_C=230^{\circ}\text{C}$		-0.35 -45	-10 -200	μA
Gate leakage current I_{GSS}	$V_{GS}=\pm 5\text{V}$, $V_{DS}=0\text{V}$ $T_C=85^{\circ}\text{C}$ $T_C=230^{\circ}\text{C}$		± 0.6 ± 170	± 5 ± 1000	nA
AC Characteristics					
Input capacitance C_{iss}	$V_{DS}=-35\text{V}$, $V_{GS}=0\text{V}$, $f=1\text{MHz}$		160		pF
Output capacitance C_{oss}			62		pF
Transfer capacitance C_{rss}			35		pF
Switching Characteristics					
Pulsed drain current I_{DM}	$V_{DS}=-20\text{V}$, V_{GS} sweep=0 to -5V, $d=0.2\%$, $\tau=1\text{ms}$ $T_C=-60^{\circ}\text{C}$ $T_C=85^{\circ}\text{C}$ $T_C=230^{\circ}\text{C}$	-6.1 -4.5 -3.7	-8.7 -6.4 -5.3		A
Total gate charge Q_g	$V_{DS}=-25\text{V}$, V_{GS} sweep=0 to -5V		4.8		nC
Turn-on delay time $t_{d(on)}$	$V_{DS}=-25\text{V}$, V_{GS} sweep=0 to -5V, $R_D=47\Omega$, $d=0.2\%$, $\tau=1\text{ms}$		9		ns
Rise time t_r	$V_{DS}=-25\text{V}$, V_{GS} sweep=0 to -5V, $R_D=47\Omega$, $d=0.2\%$, $\tau=1\text{ms}$		17		
Turn-off delay time $t_{d(off)}$	$V_{DS}=-25\text{V}$, V_{GS} sweep=0 to -5V, $R_D=47\Omega$, $d=0.2\%$, $\tau=1\text{ms}$		32		
Fall time t_f	$V_{DS}=-25\text{V}$, V_{GS} sweep=0 to -5V, $R_D=47\Omega$, $d=0.2\%$, $\tau=1\text{ms}$		44		
Drain-Source Diode Characteristics					
Forward diode voltage $V_{SD,1A}$	$V_{GS}=0\text{V}$, $I_{DS}=1\text{A}$ $T_C=-60^{\circ}\text{C}$ $T_C=85^{\circ}\text{C}$ $T_C=230^{\circ}\text{C}$		1.34 1.23 1.09		V

XTR2N0550 SPECIFICATIONS

Unless otherwise stated, specification applies for $-60^{\circ}\text{C} < T_J < 230^{\circ}\text{C}$.

Parameter	Condition	Min	Typ	Max	Units
DC Characteristics					
Drain-source breakdown voltage V_{DS}	$V_{GS}=0\text{V}$, $I_{DS}=-100\mu\text{A}$	-40			V
Static drain-source on-state resistance $R_{DS(on)}$	$V_{GS}=-5\text{V}$, $I_{DS}=-100\text{mA}$ $T_C=-60^{\circ}\text{C}$ $T_C=85^{\circ}\text{C}$ $T_C=230^{\circ}\text{C}$		0.50 0.73 1.10	0.65 0.95 1.40	Ω
Continuous drain current $I_{D(C)}$	$V_{GS}=-5\text{V}$ $T_J=-60^{\circ}\text{C}$ $T_J=85^{\circ}\text{C}$ $T_J=230^{\circ}\text{C}$	-3.3 -2.4 -2.0	-4.8 -3.5 -2.9		A
Gate threshold voltage $V_{GS(th)}$	$V_{DS}=V_{GS}$, $I_{DS}=-1\text{mA}$ $T_C=-60^{\circ}\text{C}$ $T_C=85^{\circ}\text{C}$ $T_C=230^{\circ}$		-1.26 -0.96 -0.53		V
Temperature drift of gate threshold voltage $\Delta V_{GS(th)}/\Delta T_J$	$V_{DS}=V_{GS}$, $I_{DS}=-2.5\text{mA}$		2.51		mV/ $^{\circ}\text{C}$
Off-state drain current I_{DSS}	$V_{DS}=-35\text{V}$, $V_{GS}=0\text{V}$ $T_C=85^{\circ}\text{C}$ $T_C=230^{\circ}\text{C}$		-0.75 -100	-20 -400	μA
Gate Leakage current I_{GSS}	$V_{GS}=\pm 5\text{V}$, $V_{DS}=0\text{V}$ $T_C=85^{\circ}\text{C}$ $T_C=230^{\circ}\text{C}$		± 0.8 ± 190	± 5 ± 1000	nA
AC Characteristics					
Input capacitance C_{iss}	$V_{DS}=-35\text{V}$, $V_{GS}=0\text{V}$, $f=1\text{MHz}$		360		pF
Output capacitance C_{oss}			140		pF
Transfer capacitance C_{rss}			80		pF
Switching Characteristics					
Pulsed drain current I_{DM}	$V_{DS}=-25\text{V}$, $V_{GS \text{ sweep}}=0$ to -5V , $d=0.2\%$, $\tau=1\text{ms}$ $T_C=-60^{\circ}\text{C}$ $T_C=85^{\circ}\text{C}$ $T_C=230^{\circ}\text{C}$	-13.4 -9.8 -8.1	-19.1 -14.1 -11.7		A
Total gate charge Q_g	$V_{DS}=-25\text{V}$, $V_{GS \text{ sweep}}=0$ to -5V		11		nC
Turn-on delay time $t_{d(on)}$	$V_{DS}=-25\text{V}$, $V_{GS \text{ sweep}}=0$ to -5V , $R_D=47\Omega$, $d=0.2\%$, $\tau=1\text{ms}$		10		ns
Rise time t_r	$V_{DS}=-25\text{V}$, $V_{GS \text{ sweep}}=0$ to -5V , $R_D=47\Omega$, $d=0.2\%$, $\tau=1\text{ms}$		21		
Turn-off delay time $t_{d(off)}$	$V_{DS}=-25\text{V}$, $V_{GS \text{ sweep}}=0$ to -5V , $R_D=47\Omega$, $d=0.2\%$, $\tau=1\text{ms}$		38		
Fall time t_f	$V_{DS}=-25\text{V}$, $V_{GS \text{ sweep}}=0$ to -5V , $R_D=47\Omega$, $d=0.2\%$, $\tau=1\text{ms}$		53		
Drain-Source Diode Characteristics					
Forward diode voltage $V_{SD,1A}$	$V_{GS}=0\text{V}$, $I_{DS}=1\text{A}$ $T_C=-60^{\circ}\text{C}$ $T_C=85^{\circ}\text{C}$ $T_C=230^{\circ}\text{C}$		1.16 1.00 0.85		V

XTR2N0525 TYPICAL PERFORMANCE

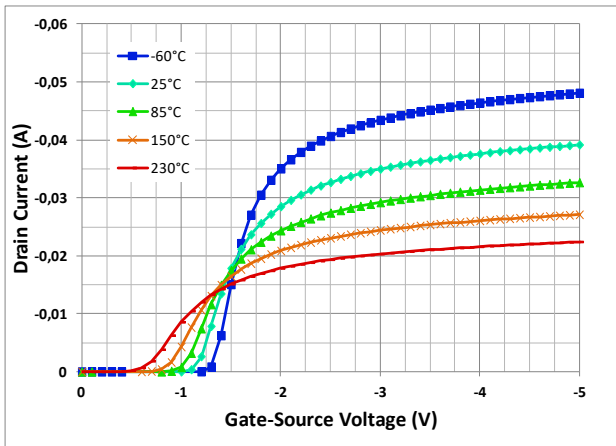

Figure 1. Drain Current (I_{DS}) vs Gate-Source Voltage for several case temperatures. $V_{DS} = -50mV$.

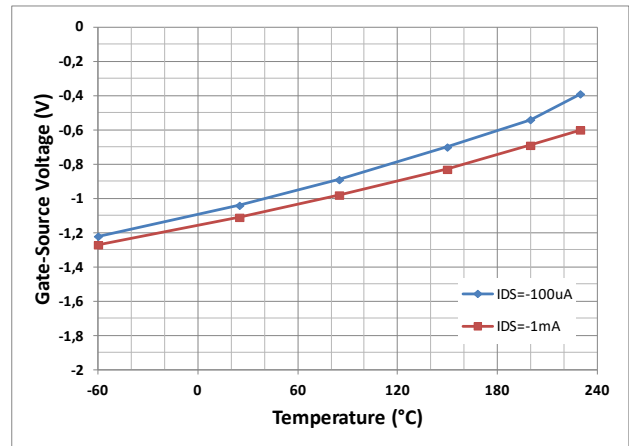

Figure 2. Gate-Source Threshold Voltage ($V_{GS(th)}$) vs Case temperatures. $V_{GS} = V_{DS}$.

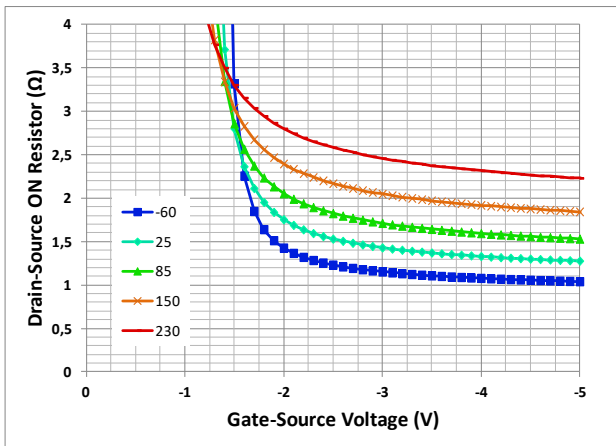

Figure 3. Drain-Source ON Resistance ($R_{DS(on)}$) vs Gate-Source Voltage for several case temperatures. $V_{DS} = -50mV$.

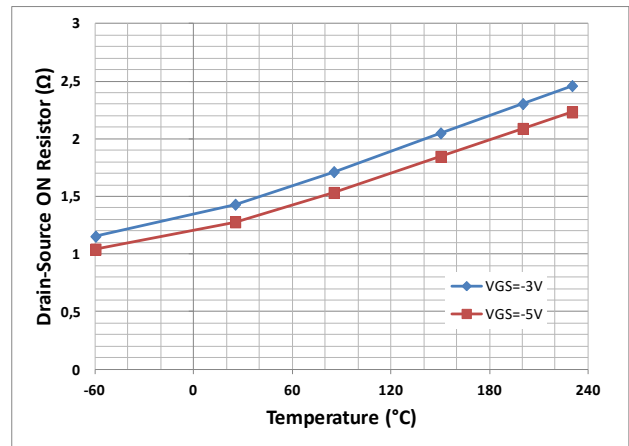

Figure 4. Drain-Source ON Resistance ($R_{DS(on)}$) vs Case Temperature. $V_{DS} = -50mV$.

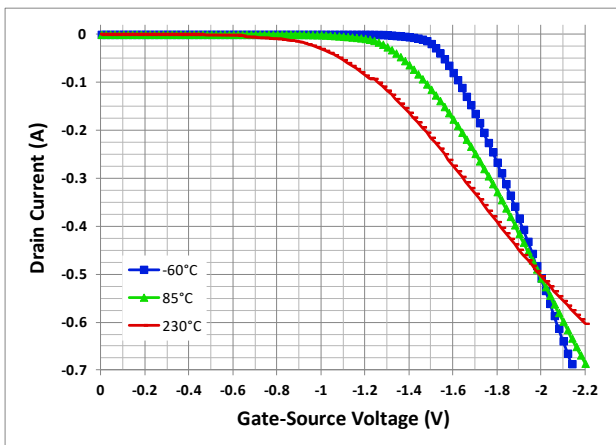

Figure 5. Drain Current (I_{DS}) vs Gate-Source Voltage for several case temperatures. $V_{GS} = V_{DS}$

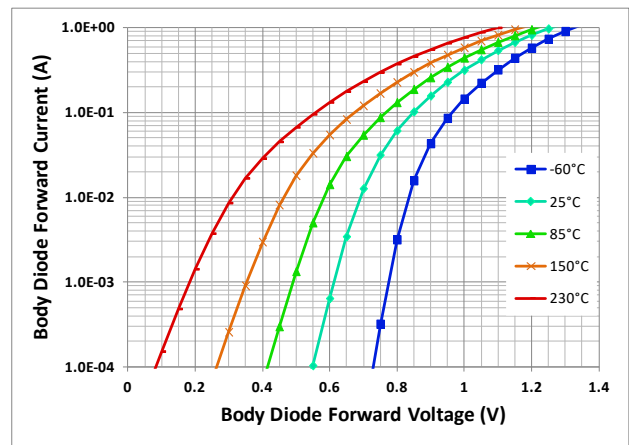

Figure 6. Body Diode Forward Current (I_{FD}) in logarithmic scale vs Forward Voltage for several case temperature. $V_{GS} = 0V$.

XTR2N0525 TYPICAL PERFORMANCE (CONTINUED)

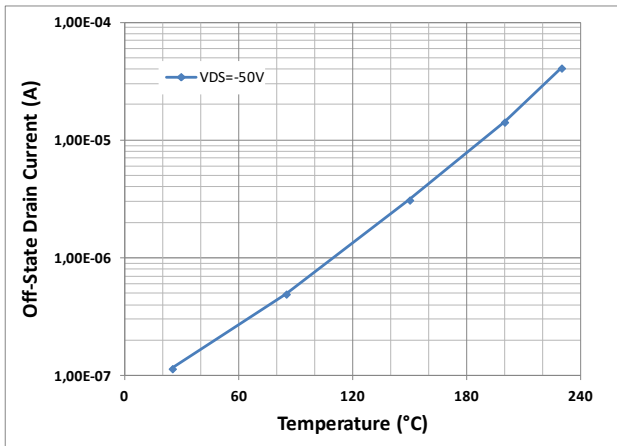

Figure 7. Off-State Drain Current (I_{oss}) vs Case Temperature. $V_{DS}=-50V$, $V_{GS}=0V$.

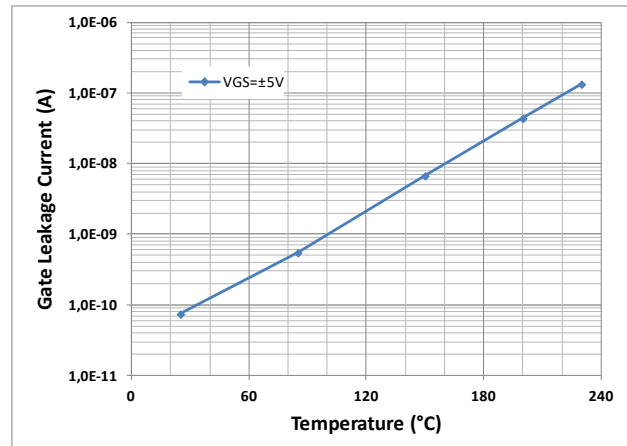

Figure 8. Gate Leakage Current (I_{gss}) vs Case Temperature. $V_{GS}=\pm 5V$, $V_{DS}=0V$.

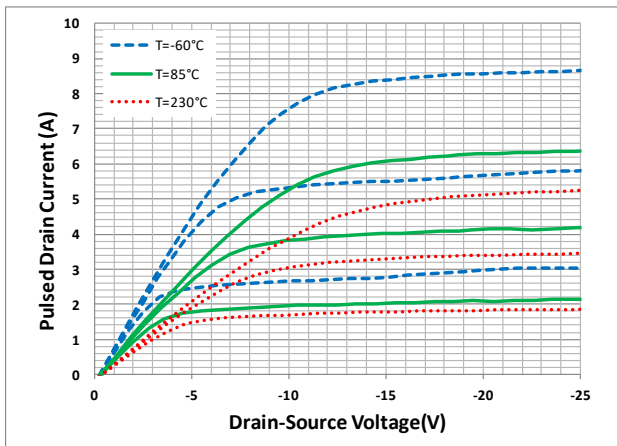

Figure 9. Pulsed Drain Current (I_{DM}) vs Drain-Source Voltage for several case temperatures. $V_{GS}=-3V, -4V$ and $-5V$.

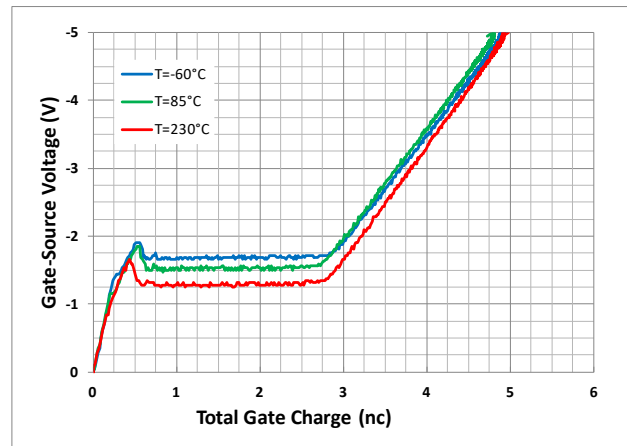

Figure 10. Total Gate Charge (Q_g) vs Gate-Source Voltage for several case temperatures. $I_{DS}=-90mA$.

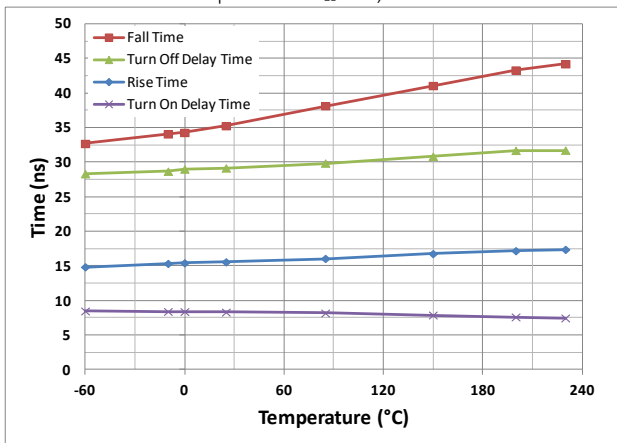

Figure 11. Timing Characteristics vs Case Temperature. $V_{DS}=-25V$, V_{GS} sweep= 0 to $-5V$.

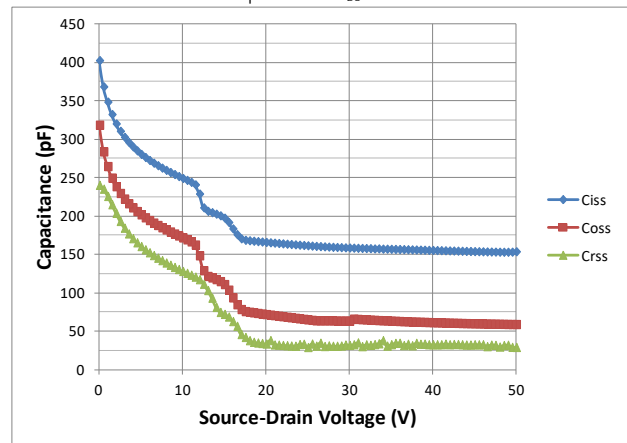

Figure 12. Capacitance vs Source-Drain Voltage at $T_c=25^\circ C$.

XTR2N0550 TYPICAL PERFORMANCE

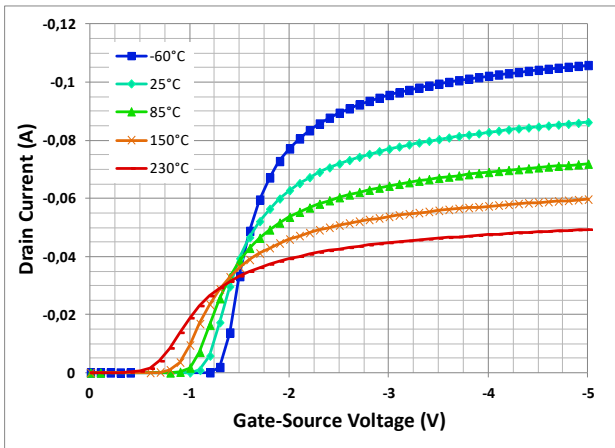

Figure 13. Drain Current (I_{DS}) vs Gate-Source Voltage for several case temperatures. $V_{DS}=-50mV$.

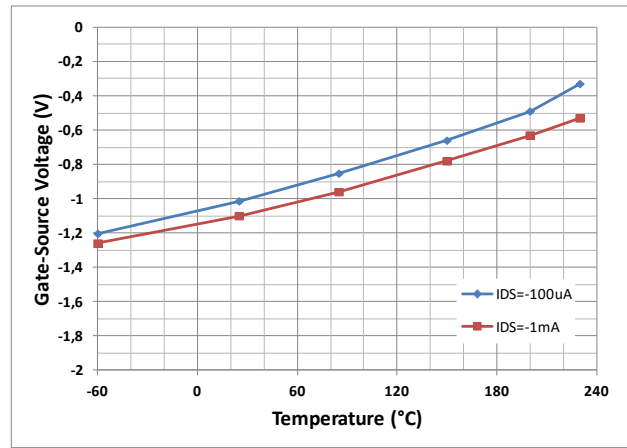

Figure 14. Gate-Source Threshold Voltage ($V_{GS(th)}$) vs Case temperatures. $V_{GS}=V_{DS}$.

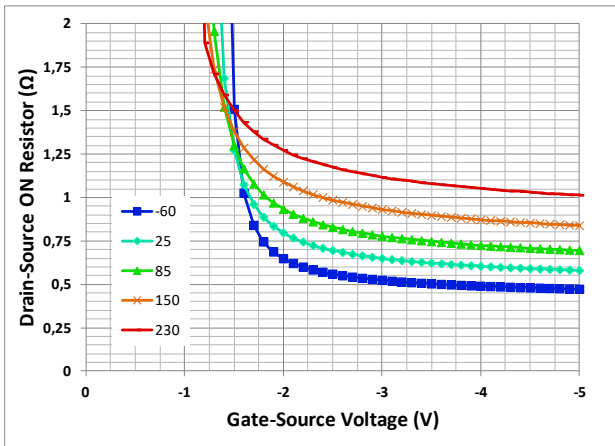

Figure 15. Drain-Source ON Resistance ($R_{DS(on)}$) vs Gate-Source Voltage for several case temperatures. $V_{DS}=-50mV$.

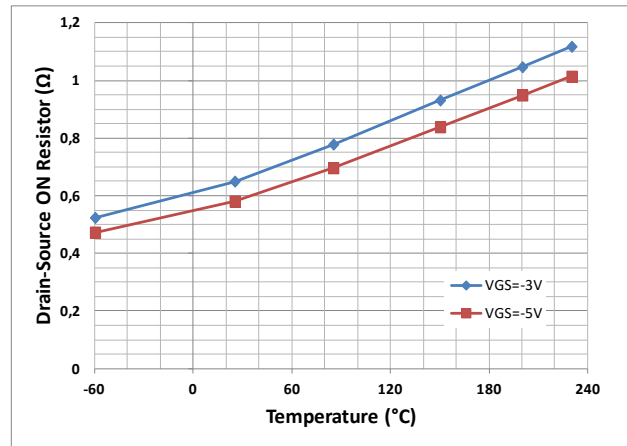

Figure 16. Drain-Source ON Resistance ($R_{DS(on)}$) vs Case Temperature. $V_{DS}=-50mV$.

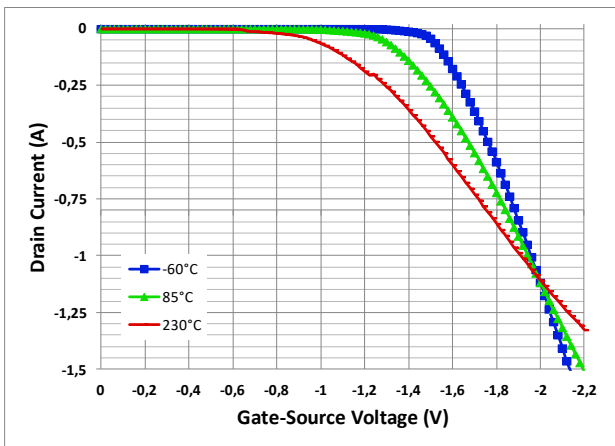

Figure 17. Drain Current (I_{DS}) vs Gate-Source Voltage for several case temperatures. $V_{GS}=V_{DS}$

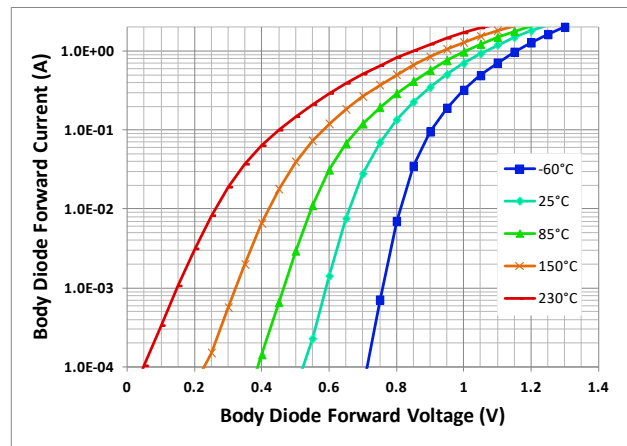

Figure 18. Body Diode Forward Current (I_{FD}) in logarithmic scale vs Forward Voltage for several case temperature. $V_{GS}=0V$.

XTR2N0550 TYPICAL PERFORMANCE (CONTINUED)

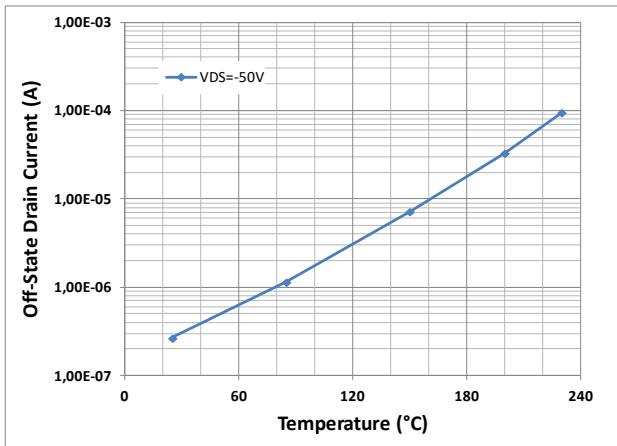

Figure 19. Off-State Drain Current (I_{DSS}) vs Case Temperature. $V_{DS}=-50V$, $V_{GS}=0V$.

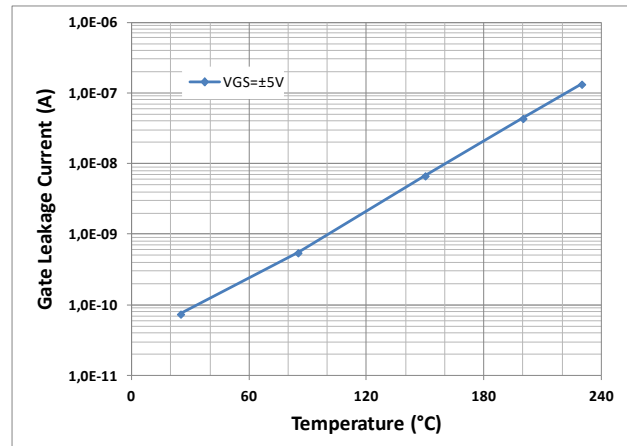

Figure 20. Gate Leakage Current (I_{GSS}) vs Case Temperature. $V_{GS}=\pm 5V$, $V_{DS}=0V$.

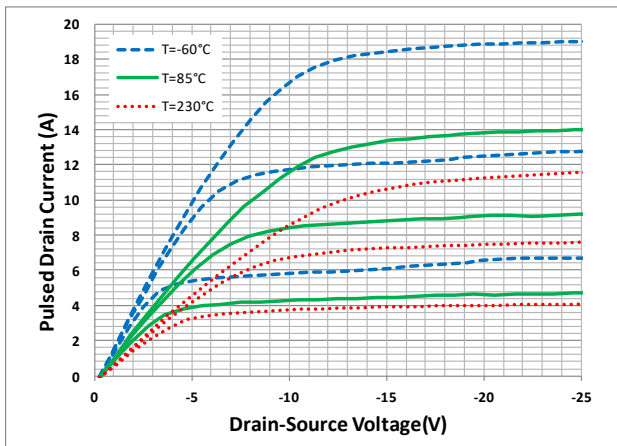

Figure 21. Pulsed Drain Current (I_{DM}) vs Drain-Source Voltage for several case temperatures. $V_{GS}=-3V, -4V$ and $-5V$.

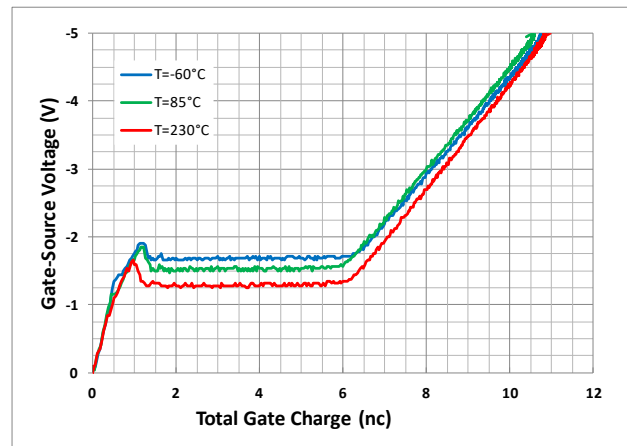

Figure 22. Total Gate Charge (Q_g) vs Gate-Source Voltage for several case temperatures. $I_{DS}=-90mA$.

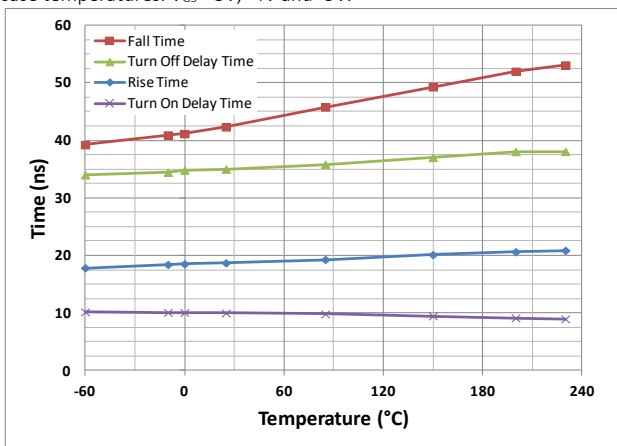

Figure 23. Timing Characteristics vs Case Temperature. $V_{DS}=-25V$, V_{GS} sweep= 0 to $-5V$.

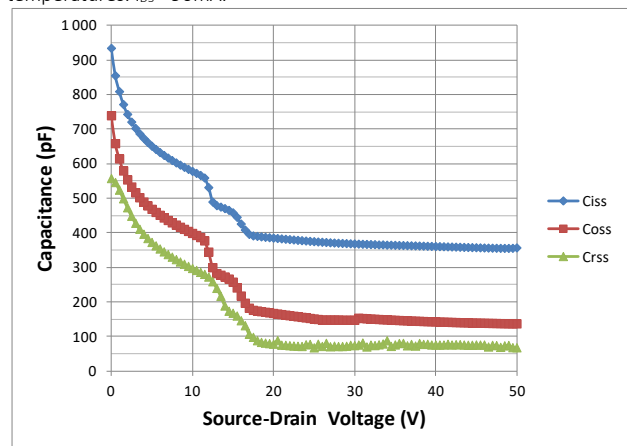

Figure 24. Capacitance vs Source-Drain Voltage at $T_c=25^\circ C$.

PARAMETER DEFINITION

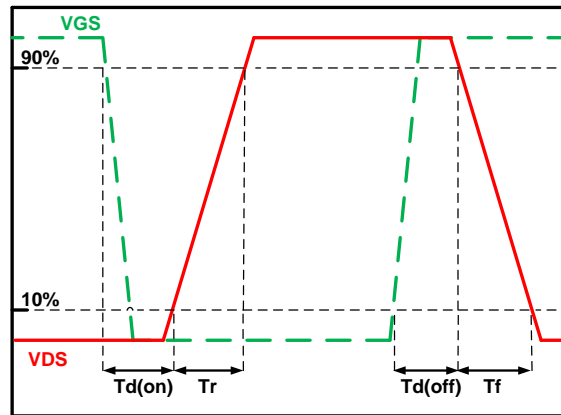
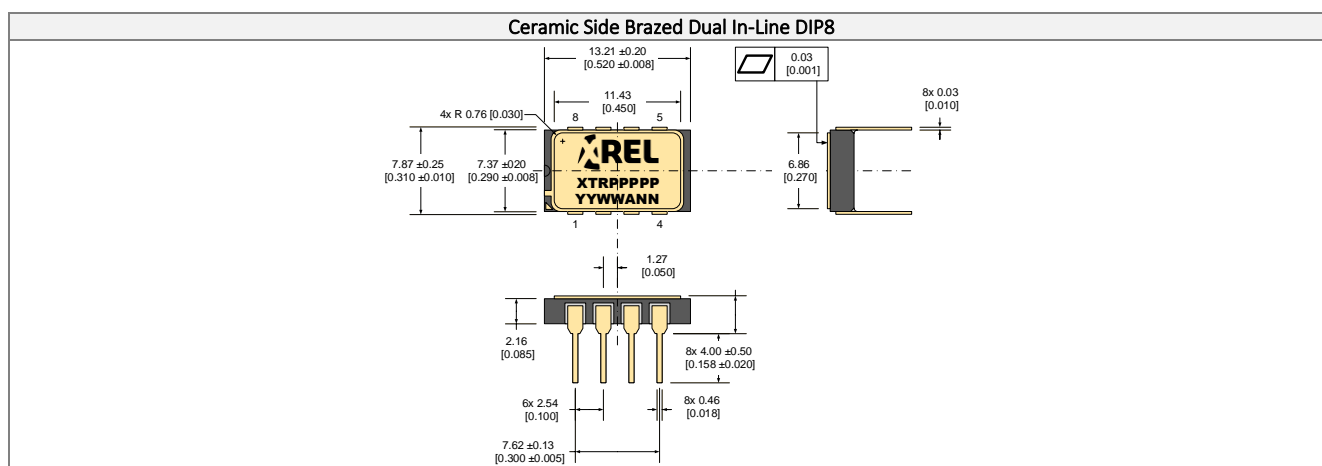
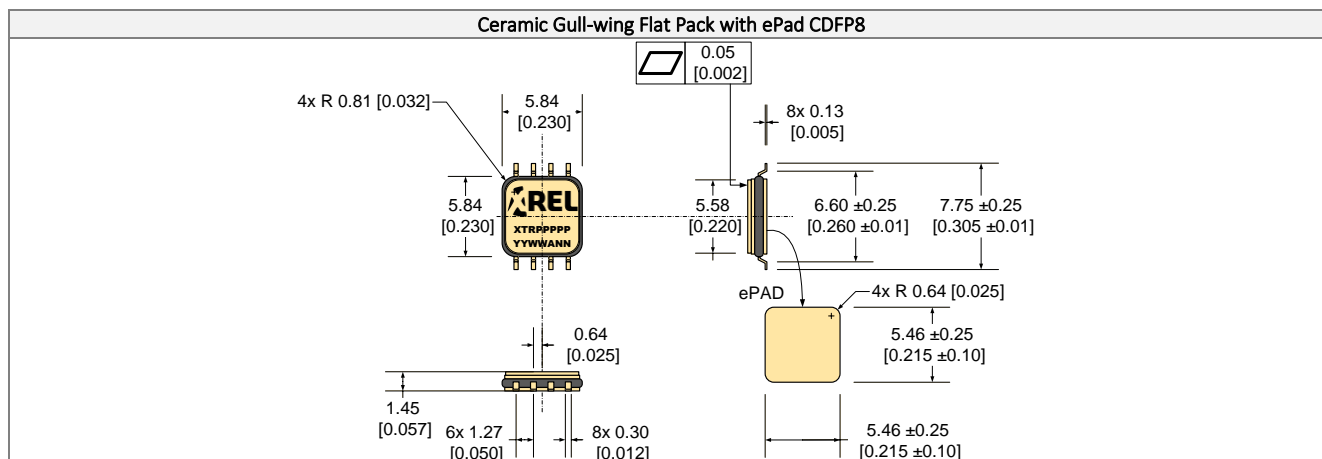

Figure 25. Timing diagram definition.

PACKAGE OUTLINES

Dimensions shown in mm [inches]. Tolerances ± 0.13 mm [± 0.005 in] unless otherwise stated.



Part Marking Convention

Part Reference: XTRPPPPP

XTR X-REL Semiconductor, high-temperature, high-reliability product (XTRM Series).

PPPPP Part number (0-9, A-Z).

Unique Lot Assembly Code: YYWWANN

YY Two last digits of assembly year (e.g. 11 = 2011).

WW Assembly week (01 to 52).

A Assembly location code.

NN Assembly lot code (01 to 99).

IMPORTANT NOTICE & DISCLAIMER

Information in this document supersedes and replaces all information previously supplied. Information in this document is provided solely in connection with EASii IC products from the X-REL business unit.

The information contained herein is believed to be reliable. EASii IC makes no warranties regarding the information contained herein. EASii IC assumes no responsibility or liability whatsoever for any of the information contained herein. EASii IC assumes no responsibility or liability whatsoever for the use of the information contained herein. The information contained herein is provided "AS IS, WHERE IS" and with all faults, and the entire risk associated with such information is entirely with the user. EASii IC reserves the right to make changes, corrections, modifications or improvements, to this document and the information herein without notice. Customers should obtain and verify the latest relevant information before placing orders for EASii IC products. The information contained herein or any use of such information does not grant, explicitly or implicitly, to any party any patent rights, licenses, or any other intellectual property rights, whether with regard to such information itself or anything described by such information.

Unless expressly approved in writing by an authorized representative of EASii IC, EASii IC products are not designed, authorized or warranted for use in military, aircraft, space, lifesaving, or life sustaining applications, nor in products or systems where failure or malfunction may result in personal injury, death, or property or environmental damage.

General Sales Terms & Conditions apply.

For product information and a complete list of distributors, please go to our web site: www.x-relsemi.com



90, Avenue Leon Blum 38100 Grenoble — France

☎ : +33 456 580 580

✉ : support.XREL@easii-ic.com

EASii IC, X-REL Semiconductor, and the logo are trademarks of EASii IC in France and other countries.
Data subject to change. Copyright © 2002-2021 EASii IC. All rights reserved.